



Product Summary

$V_{(BR)DSS}$	$R_{DS(on)TYP}$	I_D
40V	16mΩ@10V	23A
	20mΩ@4.5V	

Feature

- Trench Technology Power MOSFET
- Low $R_{DS(ON)}$
- Low Gate Charge
- Low Gate Resistance
- 100% UIS Tested

Application

- Power Switching Application

MARKING:



M150ND04L = Device Code
XX = Date Code
Solid Dot = Green Indicator

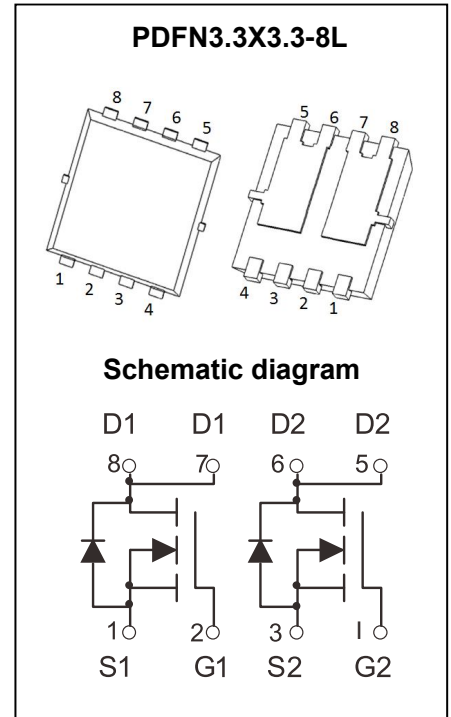

ABSOLUTE MAXIMUM RATINGS ($T_A = 25^\circ\text{C}$ unless otherwise noted)

Parameter	Symbol	Value	Unit	
Drain-Source Voltage	V_{DS}	40	V	
Gate-Source Voltage	V_{GS}	±20	V	
Continuous Drain Current ¹	$T_C = 25^\circ\text{C}$	I_D	23	A
	$T_C = 100^\circ\text{C}$	I_D	15	A
Pulsed Drain Current ²	I_{DM}	92	A	
Single Pulsed Avalanche Current ³	I_{AS}	15	A	
Single Pulsed Avalanche Energy ³	E_{AS}	56.3	mJ	
Power Dissipation ⁵	$T_C = 25^\circ\text{C}$	P_D	25	W
Thermal Resistance from Junction to Ambient ⁶	$R_{\theta JA}$	60	$^\circ\text{C/W}$	
Thermal Resistance from Junction to Case	$R_{\theta JC}$	5	$^\circ\text{C/W}$	
Junction Temperature	T_J	150	$^\circ\text{C}$	
Storage Temperature	T_{STG}	-55~ +150	$^\circ\text{C}$	

MOSFET ELECTRICAL CHARACTERISTICS ($T_A = 25^\circ\text{C}$ unless otherwise noted)

Parameter	Symbol	Test Condition	Min	Type	Max	Unit
Off Characteristics						
Drain-Source Breakdown Voltage	$V_{(BR)DSS}$	$V_{GS} = 0V, I_D = 250\mu A$	40			V
Zero Gate Voltage Drain Current	I_{DSS}	$V_{DS} = 32V, V_{GS} = 0V$			1	μA
Gate-Body Leakage Current	I_{GSS}	$V_{GS} = \pm 20V, V_{DS} = 0V$			± 100	nA
On Characteristics⁴						
Gate Threshold Voltage	$V_{GS(th)}$	$V_{DS} = V_{GS}, I_D = 250\mu A$	1.4	1.7	2.4	V
Drain-Source On-Resistance	$R_{DS(on)}$	$V_{GS} = 10V, I_D = 10A$		16	19	m Ω
		$V_{GS} = 4.5V, I_D = 10A$		20	29	
Forward Transconductance	g_{FS}	$V_{DS} = 5V, I_D = 10A$		19		S
Dynamic Characteristics						
Input Capacitance	C_{iss}	$V_{DS} = 20V, V_{GS} = 0V, f = 1MHz$		1453		pF
Output Capacitance	C_{oss}			98		
Reverse Transfer Capacitance	C_{rss}			75		
Gate Resistance	R_g	$V_{DS} = 0V, V_{GS} = 0V, f = 1MHz$		2.7		Ω
Switching Characteristics						
Total Gate Charge	Q_g	$V_{DS} = 20V, V_{GS} = 10V, I_D = 10A$		26.7		nC
Gate-Source Charge	Q_{gs}			4.3		
Gate-Drain Charge	Q_{gd}			5.7		
Turn-On Delay Time	$t_{d(on)}$	$V_{DD} = 20V, V_{GS} = 10V, I_D = 10A$ $R_G = 3\Omega$		8.9		ns
Turn-On Rise Time	t_r			5.2		
Turn-Off Delay Time	$t_{d(off)}$			28.5		
Turn-Off Fall Time	t_f			6.6		
Source-Drain Diode Characteristics						
Diode Forward Voltage ⁴	V_{SD}	$V_{GS} = 0V, I_S = 10A$			1.2	V

Notes:

- 1.The maximum current rating is limited by package. And device mounted on a large heatsink.
- 2.Pulse Test: Pulse Width $\leq 10\mu s$, duty cycle $\leq 1\%$.
- 3.EAS condition: $V_{DD} = 28V, V_{GS} = 10V, L = 0.1mH, R_G = 25\Omega$ Starting $T_J = 25^\circ\text{C}$.
- 4.Pulse Test: Pulse Width $\leq 300\mu s$, duty cycle $\leq 2\%$.
- 5.The power dissipation P_D is limited by $T_{J(MAX)} = 150^\circ\text{C}$.And device mounted on a large heatsink.
- 6.Device mounted on $1in^2$ FR-4 board with 2oz. Copper, in a still air environment with $T_A = 25^\circ\text{C}$.

Typical Characteristics

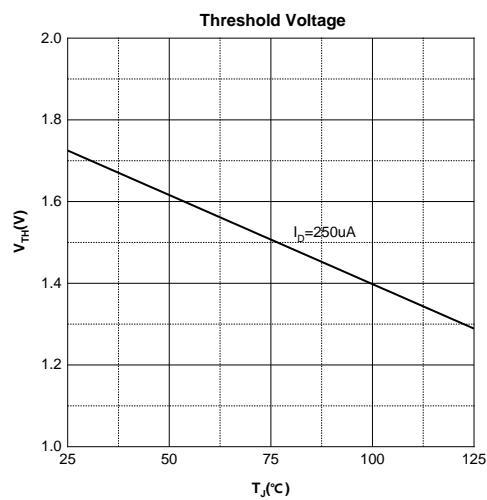
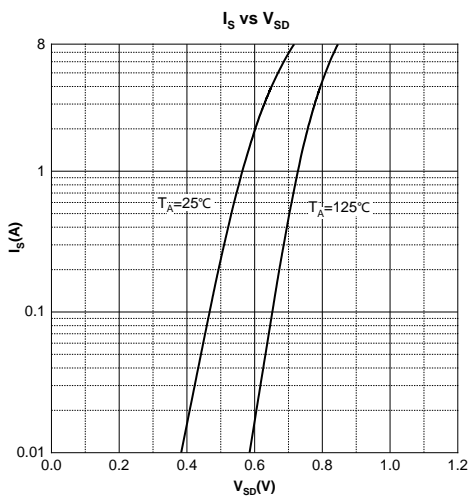
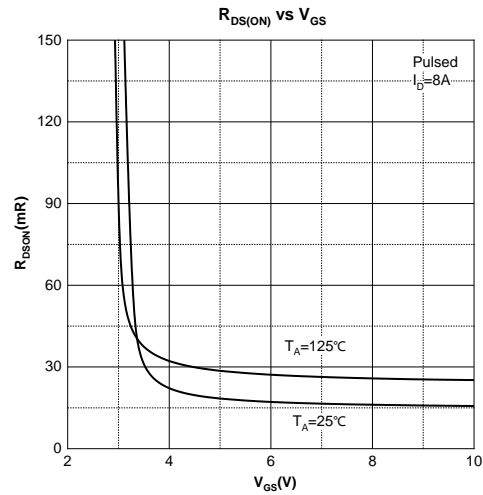
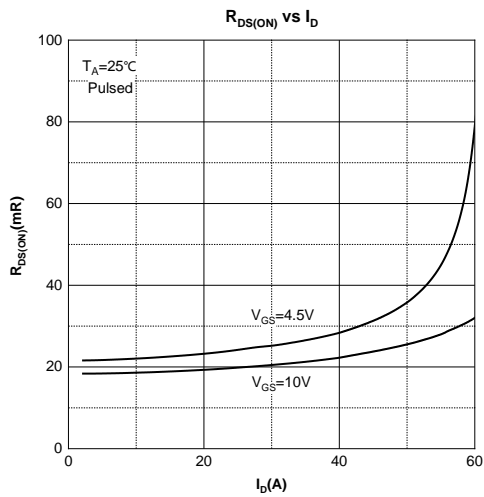
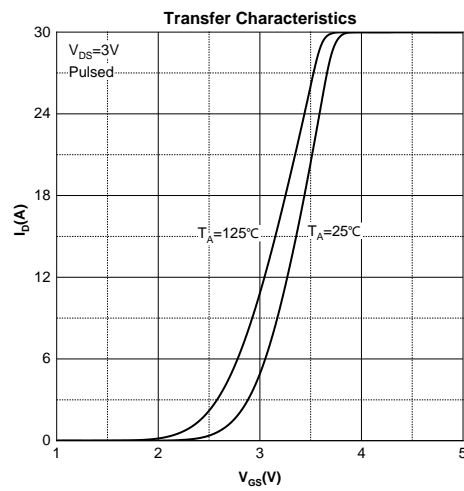
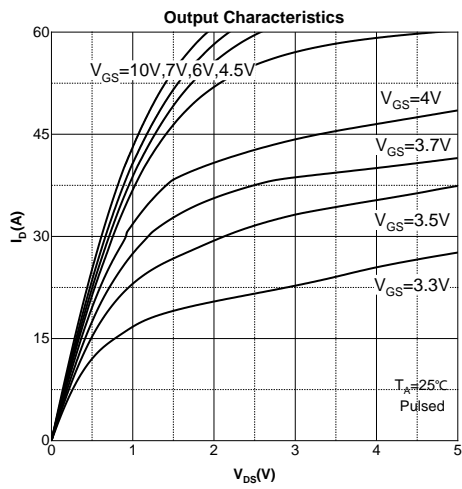

PDFN3.3X3.3-8L Package Information

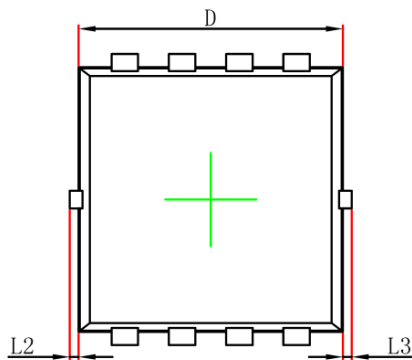

Top View
[顶视图]

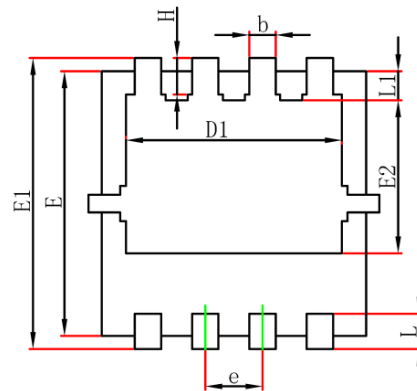

Bottom View
[背视图]

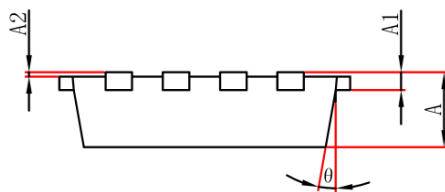

Side View
[侧视图]

Symbol	Dimensions In Millimeters		Dimensions In Inches	
	Min.	Max.	Min.	Max.
A	0.700	0.900	0.028	0.035
A1	0.152REF		0.006REF	
A2	0.000	0.050	0.000	0.002
D	2.900	3.200	0.114	0.126
D1	2.300	2.600	0.091	0.102
E	2.900	3.200	0.114	0.126
E1	3.150	3.450	0.124	0.136
E2	1.535	1.935	0.060	0.076
b	0.200	0.400	0.008	0.016
e	0.550	0.750	0.022	0.030
L	0.300	0.500	0.012	0.020
L1	0.180	0.480	0.007	0.019
L2	0.000	0.100	0.000	0.004
L3	0.000	0.100	0.000	0.004
H	0.315	0.515	0.012	0.020
θ	0°	12°	0°	12°

Attention:

- GreenPower Electronics reserves the right to improve product design function and reliability without notice.
- Any and all semiconductor products have certain probability to fail or malfunction, which may result in personal injury, death or property damage. Customer are solely responsible for providing adequate safe measures when design their systems.
- GreenPower Electronics products belong to consumer electronics or other civilian electronic products.